

TOPLITE



TOPLITE 88 FEST REDUZIERTE LEUCHTDICHTE



TOPLITE 88 FEST



TOPLITE 88 COLOR



TOPLITE QUADRATO FEST

- FESTE UND VERSTELLBAREN EINBAULEUCHTEN (WAHLWEISE RUND ODER QUADRATISCH) FÜR NIEDER-VOLTHALOGENLAMPEN.
- KÖRPER AUS ALUMINIUMDRUCKGUSS ODER STAHL, IN VERSCHIEDENEN FARBEN ERHÄLTICH.
- VERSCHIEDENE GRÖSSEN: Ø88MM, Ø100MM, Ø125MM, Ø158MM, 88x88MM UND 95x95MM.
- NEIGUNG BIS ZU 70°, DREHUNG BIS ZU 355° JE NACH AUSFÜHRUNG.
- LAMPENHALTERING AUS ALUMINIUM.
- WERKZEUGLOSER LEUCHTMITTELWECHSEL DURCH EINFACHE VIERTELDREHUNG.
- AUSFÜHRUNG IP44 MIT OBERER ABDECKUNG UND VERSCHLUSSGLAS.
- ZUBEHÖR FÜR DECKENEINBAU.
- SEPARATER TRANSFORMATOR.
- GEMÄSS EN60598-1 SOWIE WEITEREN SPEZIFIKA.



TOPLITE QUADRATISCH VERSTELLBAR



TOPLITE 100 BI-VERSTELLBAR





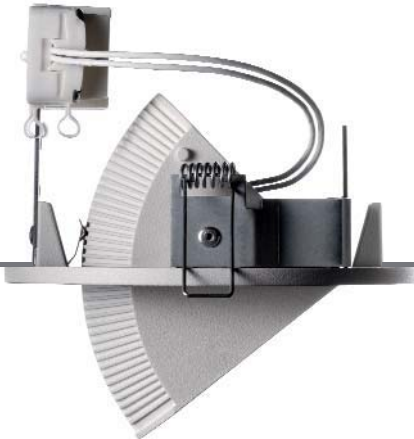

TOPLITE 125 VERSTELLBAR 70°

TOPLITE













TOPLITE 88 FEST

		 Ø75									
			 IP20 ● schwarz 1 ○ weiss 0 ● metallgrau 6								
QR-CBC51 (GU5,3) 	<table border="1"> <thead> <tr> <th>ARTIKEL</th> <th>LEUCHTMITTEL</th> <th>GEWICHT</th> </tr> </thead> <tbody> <tr> <td>M0414.0</td> <td>QR-CBC51 (GU5,3) 12V 1xmax50W</td> <td>0,13kg</td> </tr> <tr> <td>M0463.0</td> <td>QR-CBC51 (GU5,3) 12V 1xmax50W REDUZIERTE LEUCHTDICHTE</td> <td>0,13kg</td> </tr> </tbody> </table>	ARTIKEL	LEUCHTMITTEL	GEWICHT	M0414.0	QR-CBC51 (GU5,3) 12V 1xmax50W	0,13kg	M0463.0	QR-CBC51 (GU5,3) 12V 1xmax50W REDUZIERTE LEUCHTDICHTE	0,13kg	
ARTIKEL	LEUCHTMITTEL	GEWICHT									
M0414.0	QR-CBC51 (GU5,3) 12V 1xmax50W	0,13kg									
M0463.0	QR-CBC51 (GU5,3) 12V 1xmax50W REDUZIERTE LEUCHTDICHTE	0,13kg									

TOPLITE 88 IP 44/21

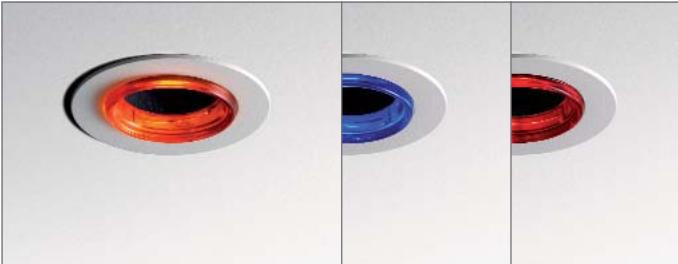
		 Ø75						
			 IP44 ● schwarz 1 ○ weiss 0 ● metallgrau 6					
QR-CBC51 (GU5,3) 	<table border="1"> <thead> <tr> <th>ARTIKEL</th> <th>LEUCHTMITTEL</th> <th>GEWICHT</th> </tr> </thead> <tbody> <tr> <td>M0430.0</td> <td>QR-CBC51 (GU5,3) 12V 1xmax50W</td> <td>0,13kg</td> </tr> </tbody> </table>	ARTIKEL	LEUCHTMITTEL	GEWICHT	M0430.0	QR-CBC51 (GU5,3) 12V 1xmax50W	0,13kg	
ARTIKEL	LEUCHTMITTEL	GEWICHT						
M0430.0	QR-CBC51 (GU5,3) 12V 1xmax50W	0,13kg						





TOPLITE 88 COLOR

		 Ø75																
			 IP20 ○ weiss															
QR-CBC51 (GU5,3) 	<table border="1"> <thead> <tr> <th>ARTIKEL</th> <th>LEUCHTMITTEL</th> <th>GLASFARBE</th> <th>GEWICHT</th> </tr> </thead> <tbody> <tr> <td>M041520</td> <td>QR-CBC51 (GU5,3) 12V 1xmax50W</td> <td>Blau</td> <td>0,13kg</td> </tr> <tr> <td>M041530</td> <td>QR-CBC51 (GU5,3) 12V 1xmax50W</td> <td>Orange</td> <td>0,13kg</td> </tr> <tr> <td>M041590</td> <td>QR-CBC51 (GU5,3) 12V 1xmax50W</td> <td>Rot</td> <td>0,13kg</td> </tr> </tbody> </table>	ARTIKEL	LEUCHTMITTEL	GLASFARBE	GEWICHT	M041520	QR-CBC51 (GU5,3) 12V 1xmax50W	Blau	0,13kg	M041530	QR-CBC51 (GU5,3) 12V 1xmax50W	Orange	0,13kg	M041590	QR-CBC51 (GU5,3) 12V 1xmax50W	Rot	0,13kg	
ARTIKEL	LEUCHTMITTEL	GLASFARBE	GEWICHT															
M041520	QR-CBC51 (GU5,3) 12V 1xmax50W	Blau	0,13kg															
M041530	QR-CBC51 (GU5,3) 12V 1xmax50W	Orange	0,13kg															
M041590	QR-CBC51 (GU5,3) 12V 1xmax50W	Rot	0,13kg															

TOPLITE 100 BI-VERSTELLBAR

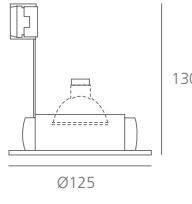
								
			<p>   IP20 ● schwarz 1 ○ weiss 0 ● metallgrau 6 </p>					
QR-CBC51 (GU5,3) 	<table border="1"> <thead> <tr> <th>ARTIKEL</th> <th>LEUCHTMITTEL</th> <th>GEWICHT</th> </tr> </thead> <tbody> <tr> <td>M0429.5</td> <td>QR-CBC51 (GU5,3) 12V 1xmax50W</td> <td>0,17kg</td> </tr> </tbody> </table>	ARTIKEL	LEUCHTMITTEL	GEWICHT	M0429.5	QR-CBC51 (GU5,3) 12V 1xmax50W	0,17kg	
ARTIKEL	LEUCHTMITTEL	GEWICHT						
M0429.5	QR-CBC51 (GU5,3) 12V 1xmax50W	0,17kg						





TOPLITE 125 FEST

								
			<p>   IP20 ○ weiss </p>					
QR-CBC51 (GU5,3) 	<table border="1"> <thead> <tr> <th>ARTIKEL</th> <th>LEUCHTMITTEL</th> <th>GEWICHT</th> </tr> </thead> <tbody> <tr> <td>M046100</td> <td>QR-CBC51 (GU5,3) 12V 1xmax50W</td> <td>0,23kg</td> </tr> </tbody> </table>	ARTIKEL	LEUCHTMITTEL	GEWICHT	M046100	QR-CBC51 (GU5,3) 12V 1xmax50W	0,23kg	
ARTIKEL	LEUCHTMITTEL	GEWICHT						
M046100	QR-CBC51 (GU5,3) 12V 1xmax50W	0,23kg						

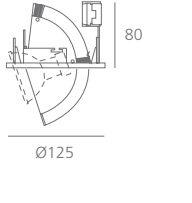
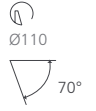

TOPLITE 125 VERSTELLBAR 30°

								
			<p>   IP20 ○ weiss </p>					
QR-CBC51 (GU5,3) 	<table border="1"> <thead> <tr> <th>ARTIKEL</th> <th>LEUCHTMITTEL</th> <th>GEWICHT</th> </tr> </thead> <tbody> <tr> <td>M046105</td> <td>QR-CBC51 (GU5,3) 12V 1xmax50W</td> <td>0,23kg</td> </tr> </tbody> </table>	ARTIKEL	LEUCHTMITTEL	GEWICHT	M046105	QR-CBC51 (GU5,3) 12V 1xmax50W	0,23kg	
ARTIKEL	LEUCHTMITTEL	GEWICHT						
M046105	QR-CBC51 (GU5,3) 12V 1xmax50W	0,23kg						

TOPLITE 125 VERSTELLBAR 70°

								
			<p>   IP20 ● schwarz 1 ○ weiss 0 ● metallgrau 6 </p>					
QR-CBC51 (GU5,3) 	<table border="1"> <thead> <tr> <th>ARTIKEL</th> <th>LEUCHTMITTEL</th> <th>GEWICHT</th> </tr> </thead> <tbody> <tr> <td>M0414.5</td> <td>QR-CBC51 (GU5,3) 12V 1xmax50W</td> <td>0,27kg</td> </tr> </tbody> </table>	ARTIKEL	LEUCHTMITTEL	GEWICHT	M0414.5	QR-CBC51 (GU5,3) 12V 1xmax50W	0,27kg	
ARTIKEL	LEUCHTMITTEL	GEWICHT						
M0414.5	QR-CBC51 (GU5,3) 12V 1xmax50W	0,27kg						

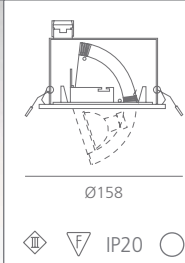
SUPERTOP

								
<p>QR-CBC51 (GU5,3) </p>	<table border="1"> <thead> <tr> <th data-bbox="475 427 592 450">ARTIKEL</th> <th data-bbox="603 427 954 450">LEUCHTMITTEL</th> <th data-bbox="965 427 1038 450">GEWICHT</th> </tr> </thead> <tbody> <tr> <td data-bbox="475 461 571 483">M044105</td> <td data-bbox="603 461 954 483">QR-CBC51 (GU5,3) 12V 1xmax50W</td> <td data-bbox="965 461 1038 483">0,45kg</td> </tr> </tbody> </table>		ARTIKEL	LEUCHTMITTEL	GEWICHT	M044105	QR-CBC51 (GU5,3) 12V 1xmax50W	0,45kg
ARTIKEL	LEUCHTMITTEL	GEWICHT						
M044105	QR-CBC51 (GU5,3) 12V 1xmax50W	0,45kg						





CITE MONDIALE DU VIN, BORDEAUX (F), PETUAUD, LETANG.



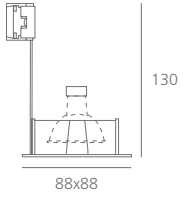

HQ'S TOYOTA MOTORS ITALIA, ROM (I), SHIGERU IWAKIRI - KENZO TANGE ASSOCIATES.



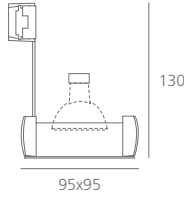

TOPLITE QUADRATISCH FEST

		 Ø75									
			IP20 ● schwarz 1 ○ weiss 0 ● metallgrau 6								
QR-CBC51 (GU5,3) 	<table border="1"> <thead> <tr> <th>ARTIKEL</th> <th>LEUCHTMITTEL</th> <th>GEWICHT</th> </tr> </thead> <tbody> <tr> <td>M0412.0</td> <td>QR-CBC51 (GU5,3) 12V 1xmax50W</td> <td>0,13kg</td> </tr> <tr> <td>M0465.0</td> <td>QR-CBC51 (GU5,3) 12V 1xmax50W REDUZIERTER LEUCHTDICHTE</td> <td>0,13kg</td> </tr> </tbody> </table>	ARTIKEL	LEUCHTMITTEL	GEWICHT	M0412.0	QR-CBC51 (GU5,3) 12V 1xmax50W	0,13kg	M0465.0	QR-CBC51 (GU5,3) 12V 1xmax50W REDUZIERTER LEUCHTDICHTE	0,13kg	
ARTIKEL	LEUCHTMITTEL	GEWICHT									
M0412.0	QR-CBC51 (GU5,3) 12V 1xmax50W	0,13kg									
M0465.0	QR-CBC51 (GU5,3) 12V 1xmax50W REDUZIERTER LEUCHTDICHTE	0,13kg									

TOPLITE QUADRATISCH VERSTELLBAR

		 83x83 30°									
			IP20 ● schwarz 1 ○ weiss 0 ● metallgrau 6								
QR-CBC51 (GU5,3) 	<table border="1"> <thead> <tr> <th>ARTIKEL</th> <th>LEUCHTMITTEL</th> <th>GEWICHT</th> </tr> </thead> <tbody> <tr> <td>M0412.5</td> <td>QR-CBC51 (GU5,3) 12V 1xmax50W</td> <td>0,18kg</td> </tr> <tr> <td>M0465.5</td> <td>QR-CBC51 (GU5,3) 12V 1xmax50W REDUZIERTER LEUCHTDICHTE</td> <td>0,13kg</td> </tr> </tbody> </table>	ARTIKEL	LEUCHTMITTEL	GEWICHT	M0412.5	QR-CBC51 (GU5,3) 12V 1xmax50W	0,18kg	M0465.5	QR-CBC51 (GU5,3) 12V 1xmax50W REDUZIERTER LEUCHTDICHTE	0,13kg	
ARTIKEL	LEUCHTMITTEL	GEWICHT									
M0412.5	QR-CBC51 (GU5,3) 12V 1xmax50W	0,18kg									
M0465.5	QR-CBC51 (GU5,3) 12V 1xmax50W REDUZIERTER LEUCHTDICHTE	0,13kg									

TOPLITE ZUBEHÖR

	M080008 Einbauring mit Gipssträger für M0414.0, M0463.0, M0430.0, M0415.0, M0412.0 und M0465.0.		M081047 Rasterblende für M0414.0, M0414.5, M0429.5, M044105, M0412.0 und M0412.5.
	M080018 Einbauring für Mineralfaserdecken M0414.0, M0463.0, M0430.0, M0415.0, M0412.0 und M0465.0.		M070211 Elektronischer Transformator 230-240V/12V. 50VA.
	M080028 Einbauring für M0414.0, M0463.0, M0430.0, M0415.0, M0412.0 und M0465.0.		